

Red Range

Red 4Pre / Red 8Pre / Red 8Line / Red 16Line

A range of up to 64 in / 64 out Thunderbolt™ audio interfaces with Pro Tools | HD and Dante® network audio connectivity

User Guide



CONTENTS

About This User Guide	4
Unit Variances	4
Box Contents	4
System Requirements	4
Introduction	5
Key Features	5
Controls and Connections	6
Front Panel – Red 4Pre / Red 8Pre	6
Front Panel – Red 8Line	7
Front Panel – Red 16Line	8
Rear Panel – Red 8Line / Red 16Line	10
Physical Characteristics	11
Power Requirements	11
Operation	12
INPUTS	12
Analogue Inputs	12
Input Controls	12
Preamp Overview Screen	12
Preamp Focus Screen	12
Input Configuration	13
Input Functions	13
Encoder Toggle Function	14
Line Inputs	14
Operating Level Selection	14
DIGITAL INPUTS	15
ADAT	15
S/PDIF	15
Loopback Input	15
DANTE CONNECTION	15
MONITORING	16
Monitors	16
Monitor Display	16
Mute and Dim	16
Headphones	16

Contents

LCD METER DISPLAYS	17
Red 4Pre, Red 8Pre and Red 8Line	17
Meter Source Selection – Red 4Pre and Red 8Pre	17
Meter Source Selection – Red 8Line	17
Red 16Line	18
Level Meters 1–8 and 9–16	18
Output Meter	18
Meter Source Selection	18
ANALOGUE OUTPUTS	19
Operating Level Selection	19
THUNDERBOLT CONNECTION	20
Logic Pro X Setup	20
PRO TOOLS CONNECTION	21
Using Red Range Units with other Pro Tools HD interfaces	21
Loop Sync	21
Pro Tools Setup	22
Global Settings	23
Host	23
Sync	23
Retain	23
I/O level (<i>Red 16Line only</i>)	23
Other Red System Components	24
REDNET CONTROL 2	24
Tools Menu	24
Appendices	27
Appendix 1 – Connector Pinouts	27
Appendix 2 – System Diagrams	29
Appendix 3 – I/O Channel Allocation	32
Appendix 4 – Air Information	44
Performance and Specifications	45
Focusrite Pro Warranty and Service	48
Registering Your Product	48
Customer Support and Unit Servicing	48
Troubleshooting	48

About This User Guide

This user guide is applicable to all units in the Red range of Thunderbolt Interfaces: Red 4Pre, Red 8Pre, Red 8Line and Red 16Line. It provides information about installation, operation and how each unit can be connected into your home or studio system.

Unit Variances

- Where channel quantities differ between each device, the channel counts are shown in squared brackets in the order: [Red 4Pre / Red 8Pre / Red 8Line / Red 16Line].

Eg., “Connectors for the [4/8/2/2] microphone inputs are located on the rear panel.”

- Individual specification differences will be indicated by notes eg., “(Not available on Red 16Line)”
- Where there are significant specification variations, a separate page is used for each version.

Audinate® and Dante® are registered trademark of Audinate Pty Ltd.

Thunderbolt™ is a trademark of Intel Corporation or its subsidiaries in the U.S. and/or other countries.

Box Contents

- Red range unit
- IEC AC mains cable
- 2m Thunderbolt 2 cable (*Red 4Pre and Red 8Pre only*)
- 2m Thunderbolt 3 cable – 20Gbps, 60W (*Red 8Line and Red 16Line only*)
- Product registration card, which provides the following important information:
 - Unit serial number
 - Bundle code – *for registering your product and for accessing your free software*

System Requirements

- An Apple Mac with at least one Thunderbolt, Thunderbolt 2 or Thunderbolt 3 port, or a Pro Tools | HD system for mini DigiLink connection
An Apple Thunderbolt 3 to Thunderbolt 2 adapter and a Thunderbolt 2 cable will be required to connect any Thunderbolt or Thunderbolt 2 ports to a Thunderbolt 3 port
- See <https://focusrite.com/downloads/os> for information on OS compatibility
- Internet connection for downloading and installing software and driver

INTRODUCTION

Thank you for purchasing your Focusrite Red range unit.



Red range interface units combine dual Thunderbolt and Pro Tools | HD audio interfaces with preamplifiers, suitable for a wide range of audio integration applications.

All units feature Mic, Line and Instrument analogue inputs with either 14 or 22 analogue output channels including independent loudspeaker and headphone monitoring, ADAT and S/PDIF digital I/O plus LCD meter displays. Red units provide an interface for Pro Tools | HD equipped workstations and, with their built-in Dante card, are ready for networked audio expansion via dual Ethernet ports.

Key Features

- Two Thunderbolt Interface ports for direct or chained connection (*Thunderbolt 2 on Red 4Pre and Red 8Pre; Thunderbolt 3 on Red 8Line and Red 16Line*).
- [8/16/8/16] line-level input and output signals via DB25 connectors on the rear panel.
- [4/8/2/2] remote controlled microphone preamps providing up to 63dB of gain, each with phantom power, high-pass filter, phase-reverse and 'Air' mode. *See Appendix 3 on p.28 for further information.*
- Two instrument inputs accessed via front-mounted 1/4" jacks.
- Analogue monitoring via dedicated balanced 1/4" jack outputs on the rear panel, plus two independent headphone outputs on the front panel.
- Digital devices can be accommodated via the S/PDIF and dual optical ADAT I/O connections.
- Two Primary Mini DigiLink connectors provide [58/64/58/64] input and 64 output channels of I/O to Pro Tools | HD.
- Dual Ethernet ports provide up to 32 x 32 channels of networked audio expansion over Dante.
- BNC connectors allow syncing or slaving to external devices via Word Clock or Loop Sync.
- Permanent 8-channel LCD meter display (*Red 4Pre, Red 8Pre and Red 8Line*), selectable to show all input or output types.
- Two 8-channel LCD meter displays (*Red 16Line*) show 16 Inputs, 16 Outputs or a combined I/O view.
- Line Input & Output operating levels selectable to +18 dBu or +24 dBu, globally or independently for each channel (*Red 8Line and Red 16Line only*).
- Simple host and sync selection setup.
- RedNet Control 2 application allows full remote hardware operation and setup, plus control of mixing and routing.

Controls and Connections

Front Panel – Red 4Pre / Red 8Pre

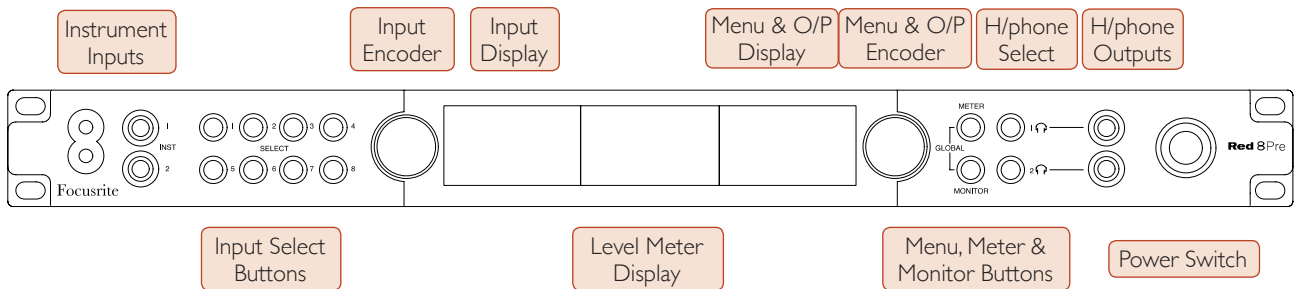

- **Instrument Inputs.** Two high-impedance inputs on 1/4" jack sockets.
 - **Input Select buttons** provide direct access to the control and menu settings for analogue input channels [1-4/1-8].
 - The **Input Encoder** and its associated **Input Display** is used to select and adjust the configuration menu settings for the input channels; it also functions as the input gain control for the active channel.
 - The **Level Meter Display** is an eight channel, switchable LCD meter which is able to display groups of input and output signals.
 - The **Output Encoder** functions as the volume control for the monitor and headphone outputs. It is also used to configure the global system settings, control the meter selection and select the monitor dim and mute features. Its function is determined by the adjacent Monitor, Meter and Headphone Select buttons.
 - The **Meter** button calls up the selection menu for the level meters onto the **Output Display**.
 - The **Monitor** button assigns the **Output Encoder** to the monitor loudspeaker functions.
- Pressing the **Meter** and **Monitor** buttons simultaneously enters the **Global** configuration menu, where host, clock and power-up settings are assigned.*
- The **Headphone 1** and **2** buttons assign the **Output Encoder** to the selected headphone control functions.
 - **Headphone Outputs** are standard 1/4" TRS jacks.

Front Panel – Red 8Line

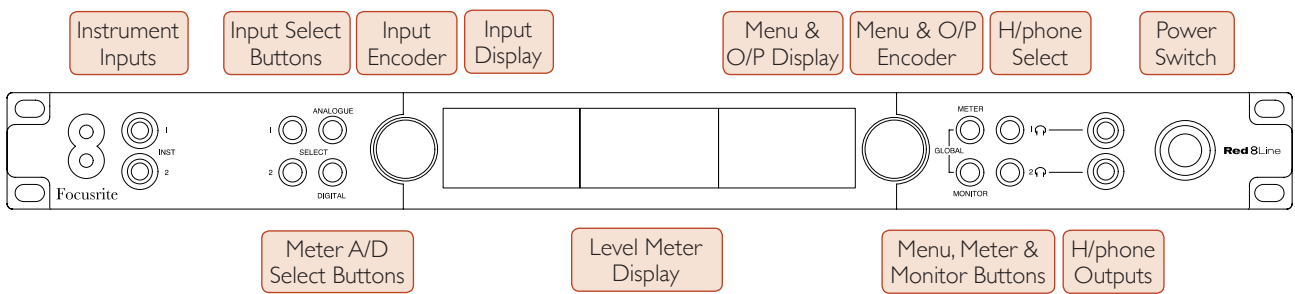

- **Instrument Inputs.** Two high-impedance unbalanced inputs on 1/4" jack sockets.
- **Input Select buttons** provide direct access to the menu settings for analogue input channels 1&2.
- The **Input Encoder** and its associated **Input Display** is used to select and adjust the configuration menu settings for the input channels; it also functions as the input gain control for inputs 1&2.
- The **Level Meter Display** is an eight channel, switchable LCD meter which is able to display groups of input or output signals.
- The **Analogue** button shows the analogue signals on the level meter display; pressing Analogue again toggles between inputs and outputs.
- The **Digital** button shows the digital signals on the level meter display; the group of signals to show is selected by the pressing the **Meter** button and then rotating the Output Encoder. Pressing the Digital button again toggles between inputs and outputs.
- The **Output Encoder** functions as the volume control for the monitor and headphone outputs. It is also used to configure the global system settings, control the digital meter selection and select the monitor dim and mute features. Its function is determined by the adjacent Monitor, Meter and Headphone Select buttons.
- The **Monitor** button assigns the **Output Encoder** to the monitor loudspeaker functions.
*Pressing the **Meter** and **Monitor** buttons simultaneously enters the **Global** configuration menu, where host, clock and power-up settings are assigned.*
- The **Headphone** 1 and 2 buttons assign the **Output Encoder** to the selected headphone control functions.
- **Headphone Outputs** are standard 1/4" TRS jacks.

Front Panel – Red 16Line

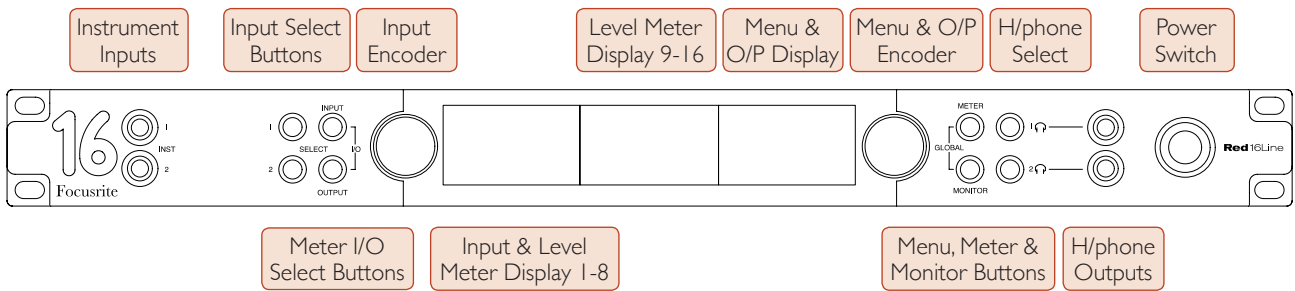

- **Instrument Inputs.** Two high-impedance unbalanced inputs on 1/4" jack sockets.
- **Input Select buttons** provide direct access to the menu settings for analogue input channels 1&2.
- The **Input Encoder** and its associated **Input Display** is used to select and adjust the configuration menu settings for the input channels; it also functions as the input gain control for inputs 1&2.
- The **Level Meter Displays 1-8** and **9-16** are switchable LCD meters able to show inputs, outputs or a combined I/O display. Display selection is made using the **Input** and **Output** buttons – pressing both buttons simultaneously selects combined I/O.
- The **Output Encoder** functions as the volume control for the monitor and headphone outputs. It is also used to configure the global system settings, control the meter selection and select the monitor dim and mute features. Its function is determined by the adjacent Monitor, Meter and Headphone Select buttons.
- The **Meter** button switches the left and centre LCD screens between: preamp info/meters 1&2, and, meters 1-8/meters 9-16; pressing a second time calls up the meter source list onto the **Output Display**.
- The **Monitor** button assigns the **Output Encoder** to the monitor loudspeaker functions.

*Pressing the **Meter** and **Monitor** buttons simultaneously enters the **Global** configuration menu where host, clock, power-up and I/O linking settings are assigned.*

- The **Headphone 1** and **2** buttons assign the **Output Encoder** to the selected headphone control functions.
- **Headphone Outputs** are standard 1/4" TRS jacks.

Rear Panel – Red 4Pre / Red 8Pre

Red 8Pre shown:

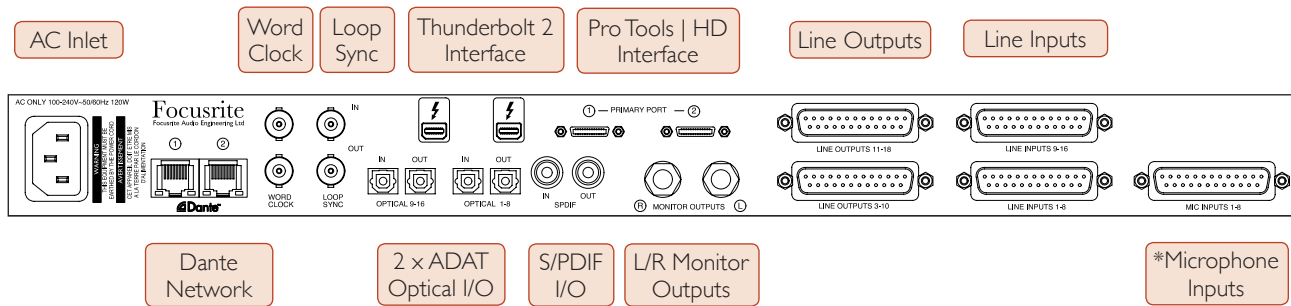

- **AC Mains Inlet.** Standard IEC receptacle for connection of AC mains. The units feature 'Universal' PSUs, enabling them to operate on any supply voltage between 100 V and 240 V AC.
- **Word Clock – Input** allows synchronisation to word clock.
- **Word Clock – Output** provides an output of the chosen system clock reference.
- **Loop Sync I/O** sockets allows integration with a standard Pro Tools system I/O chain.
- Dual **Thunderbolt 2** Connection. Two ports allow either direct or chained connection to your workstation/external monitors – the chaining/linking of other Red devices is not permitted.
- **Pro Tools | HD Interface.** Two Mini DigiLink Primary connectors; use Mini DigiLink cables to connect to a Pro Tools | HDX PCIe card or Pro Tools | HD Native system.
- **Line Outputs** on [one/two] DB25 female connector[s].
- **Line Inputs** on [one/two] DB25 female connector[s].
Note that Line input circuits [1-4/1-8] can be re-assigned to the Instrument (circuits 1&2) and/or Microphone connectors so may not always be available on the DB25 connector. See page 14 for further information.
- ***Microphone Inputs (Red 4Pre)** on four latching XLR-3 female connectors.
- ***Microphone Inputs (Red 8Pre)** on DB25 female connector.
Note that a DB25 male to XLR-3 female 8-way adapter loom will be required for mic leads with individual XLRs.
- **Network.** Two RJ45 Ethernet connectors for the Dante network. The ports can be configured as either primary and secondary on redundant systems – where two independent networks are available, or as a two-port switch to allow the daisy-chaining of additional units.
- **ADAT I/O 1 and 2.** Two independent 8-channel ADAT optical inputs and outputs using standard TOSLINK connectors. Optical I/O 1 can also be used in 'Optical S/PDIF' mode.
- **S/PDIF I/O.** 2-channel digital interface on RCA (phono) connectors.
- **Monitor Outputs.** Balanced 1/4" TRS jacks for connection of Left and Right monitor loudspeakers. Outputs are at line level so unpowered speakers will require external amplification.

Rear Panel – Red 8Line / Red 16Line

Red 16Line shown:

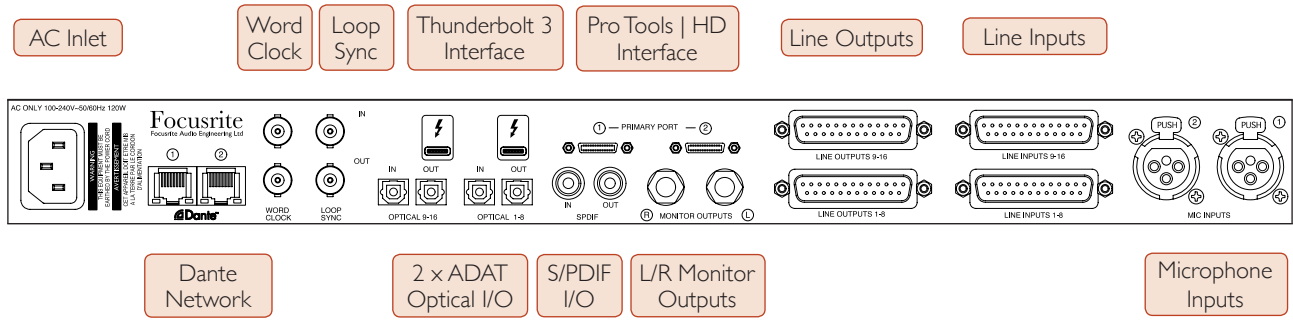

- **AC Mains Inlet.** Standard IEC receptacle for connection of AC mains. Red 16Line features a 'Universal' PSU, enabling it to operate on any supply voltage between 100 V and 240 V AC.
- **Word Clock – Input** allows synchronisation to word clock.
- **Word Clock – Output** provides an output of the chosen system clock reference.
- **Loop Sync I/O** sockets allow Red 16Line to integrate with a standard Pro Tools system I/O chain.
- **Dual Thunderbolt 3 Connection.** Two ports allow either direct or chained connection to your workstation/external monitors – the chaining/linking of other Red devices is not permitted.
- **Pro Tools | HD Interface.** Two Mini DigiLink Primary connectors; use Mini DigiLink cables to connect to a Pro Tools | HDX PCIe card or Pro Tools | HD Native system.
- **Line Outputs** on [one/two] DB25 female connector(s).
DB25 connectors are wired according to the AES59 Standard (also known as the TASCAM Analogue standard).
- **Line Inputs** on [one/two] DB25 female connector(s).
Note that Line input circuits 1 & 2 can be re-assigned to the Microphone and/or Instrument connectors so may not always be available on the input connector. See page 14 for further information.
- **Microphone Inputs** on two XLR-3 female connectors.
- **Network.** Two RJ45 Ethernet connectors for the Dante network. The ports can be configured as either primary and secondary on redundant systems – where two independent networks are available, or as a two-port switch to allow the daisy-chaining of additional units.
- **ADAT I/O 1 and 2.** Two independent 8-channel ADAT optical inputs and outputs using standard TOSLINK connectors. Optical I/O 1 can also be used in 'Optical S/PDIF' mode.
- **S/PDIF I/O.** 2-channel digital interface on RCA (phono) connectors.
- **Monitor Outputs.** Balanced 1/4" TRS jacks for connection of Left and Right monitor loudspeakers. Outputs are at line level so unpowered speakers will require external amplification.

See Appendix 1, page 27 for the connector pinouts.

Physical Characteristics

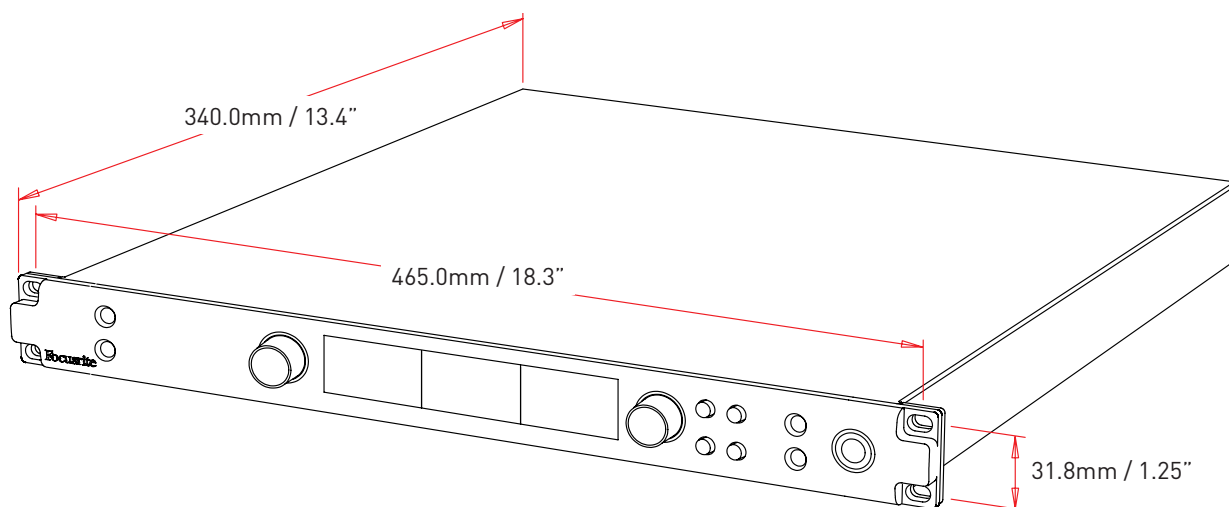

Case dimensions are illustrated in the diagram above.

Red range units require 1U of vertical rack space. Allow an additional 75mm of rack depth behind each unit to allow for cables. For installations in a fixed environment (eg., a studio), the front-panel rack mountings* will provide adequate support. However, if the units are to be used in a mobile situation (eg., flight-cased for touring, etc.), it is recommended that side support rails or shelves are used within the rack. The weight of each unit is shown in the table below.

**Always use M6 bolts and cage nuts specifically designed for 19" equipment racks. An Internet search using the phrase "M6 cage nuts" will reveal suitable components.*

Cooling is by fan assistance from side to side; the fans used are low-speed and low-noise. Do not mount the unit immediately above any other equipment which generates significant heat, for example, a power amplifier. Also, ensure that when mounted in a rack the side vents are not obstructed.

Note. The maximum operating environmental temperature is 40°C / 104°F.

Power Requirements

Red range units are mains powered and incorporate a 'Universal' power supply which can operate on any AC mains voltage from 100 V to 240 V. The AC connection is via a standard 3-pin IEC connector on the rear panel. Power consumption is shown in the table.

Unit	Weight	Power Consumption
Red 4Pre	4.59 kg	35 W
Red 8Pre	5.14 kg	65 W
Red 8Line	4.84 kg	120 W
Red 16Line	5.04 kg	120 W

A mating IEC cable is supplied with each unit – this should be terminated with a mains plug of the correct type for your country.

Please note that there are no fuses or other user-replaceable components of any type in any unit. Please refer all servicing issues to the Customer Support Team (see "Customer Support and Unit Servicing" on page 48).

OPERATION

Inputs

Each Red range device has the capacity to accommodate [8/16/8/16] analogue inputs, two independent 8-channel ADAT inputs, a 2-channel S/PDIF input plus 32 Dante input channels. Additionally, an internal 2-channel loopback signal can be added as an extra stereo input – see page 15 for details.

Analogue Inputs

Analogue inputs can be assigned to the Line, Instrument or Mic input connectors. The table shows which channels can be assigned for each Red range unit:

Unit	Instrument	Microphone	Line
Red 4Pre	Ch. 1-2	Ch. 1-4	Ch. 1-8
Red 8Pre	Ch. 1-2	Ch. 1-8	Ch. 1-16
Red 8Line	Ch. 1-2	Ch. 1-2	Ch. 1-8
Red 16Line	Ch. 1-2	Ch. 1-2	Ch. 1-16

Input Controls

Input selection and configuration for the assignable channels is carried out using the Preamp **Select** buttons and the **Input Encoder**.

The illuminated Select button identifies the channel being controlled.

- Pressing a Select button makes that channel the active channel
Power-up always selects channel 1
- Pushing ('clicking') the Input Encoder selects menu options or operates the Toggle function (see page 14)



Select Buttons / Input Encoder
Red 4Pre shown

Preamp Overview Screen

Press any Select button to recall the Overview screen on the Left LCD display. It shows the input assignment, the gain value and phantom power status for the device's input channels.

The highlighted number indicates the currently active channel.

A clipping channel will be indicated by its gain level bar changing to red – clear by pressing that channel's Select button.

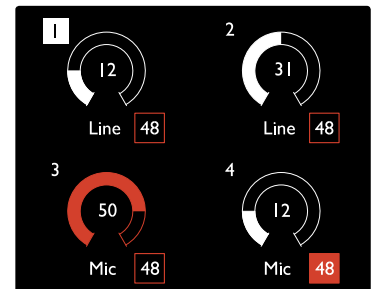

Preamp Overview Screen
Red 4Pre shown

Preamp Focus Screen

Pressing an input's Select button brings up the Focus screen which provides additional detail about that channel's settings.

If no changes are made within approximately 3 seconds, the display will revert to the Overview screen.

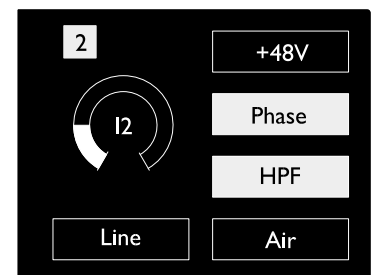

Preamp Focus Screen
Red 4Pre and Red 8Pre

Inputs...

Input Configuration

Settings for the configurable input channels – input Type and function options – are selected via the Config Menu screen.

- To enter the Config Menu press-and-hold a channel's Select button

To exit this screen press any of the channel Select buttons – or rotate the Input Encoder to the 'Back' option and then click.

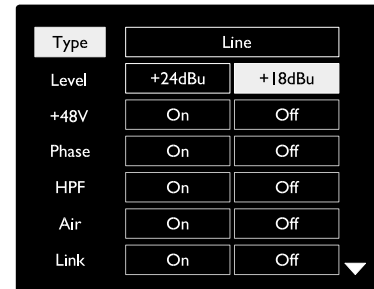

Channel Config Menu Screen
Red 16Line shown

Input Functions

The following channel functions can be set, or toggled On/Off, from the Config Menu screen:

- **Type** selects the signal input type to be used for a channel: Instrument > Mic > Line
- **Level** (Red 8 Line and 16Line) sets the operating level for the selected channel. Note that all other function settings will be greyed-out when input Type is set to 'Line'
- **+48V** enables phantom power for the microphone input
- **Phase** applies phase inversion to the selected channel
- **HPF** switches in the 80Hz high-pass filter
- **Air** changes the microphone and instrument input characteristics to 'Air' mode. See Appendix 4, page 44 for further information
- **Link** combines adjacent odd/even channels so they operate as a stereo pair. When linked, Gain and Input Type changes to either of the paired channels will be applied to both
When linked, any difference in gain settings between the two channels will be maintained.
- **Back** exits the Config Menu screen and returns to the Overview display
Pressing any of the channel Select buttons will also exit the Config menu screen

To change an input function:

- 1 Rotate the Input Encoder until the required function is highlighted
- 2 Push the Input Encoder to step through the input types or to toggle the selection

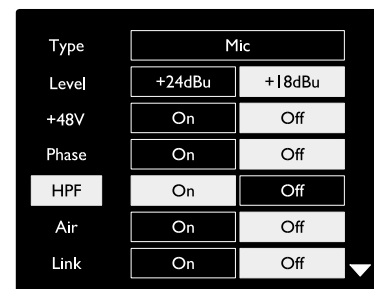

Channel Function Selection
Red 16Line shown

Inputs...

Encoder Toggle Function

The Input Encoder can be programmed to toggle any one of the input functions with a single push (ie., without having to enter the Config Menu screen). *This can be very useful when, for example, experimenting with microphone phasing.*

To select a function for the Input Encoder toggle feature:

- 1 Enter the Config Menu screen
- 2 Scroll to the function required for the toggle feature
- 3 Press-and-hold the Input Encoder until the confirmation message appears in the input display

The selected function will now toggle on/off each time the Input Encoder is clicked*. If 'Type' (default) is selected, clicking the Input Encoder will step through the available inputs.

**Selecting a function that is not available for the current input type will have no effect, but the function will be stored and become active when an appropriate input type is selected.*

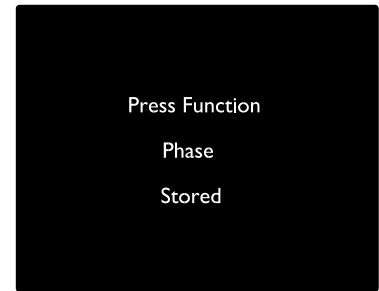
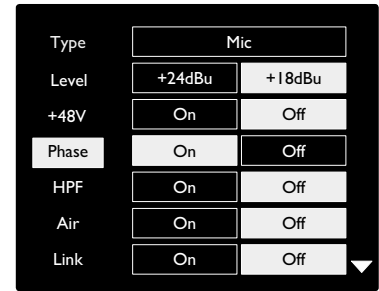

Input Encoder Toggle Confirmation

Line Inputs

Although some analogue input channels can be assigned to the Mic and Instrument connectors, the remaining Line inputs are always available on the DB25 connector(s) on the rear panel.

Operating Level Selection

(Red 16Line only – also see: 'Input/Output Line Level Setup' on page 26.)

The operating level for each Line input can be switched between +18 dBu and +24 dBu to correctly match additional studio equipment.

To set the level:

- 1 Press and hold the **Input** button until the Level Selection menu appears on the Input Display
- 2 Scroll to the required channel number for individual selection or to **All** for global selection
- 3 Click the Input Encoder to toggle between +18 dBu and +24 dBu
- 4 Press the Input button again to exit

Input and output operating level selection can be linked or unlinked. Refer to: Global Settings – I/O Level on page 23 for additional information.

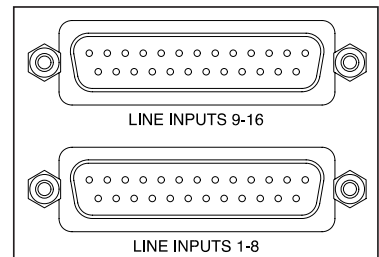

Digital Inputs

ADAT

ADAT inputs 1 and 2 are accessed via the rear panel connectors. Signals will be available if the source is connected and the system is synced to a common clock.

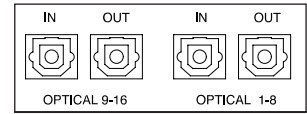

Each In/Out connection provides:

- 8ch at 44.1 / 48 kHz
- 4ch at 88.2 / 96 kHz (SMUX)
- 2ch at 176.4 / 192 kHz (SMUXII)

S/PDIF

A two-channel S/PDIF I/O connection is accessed via the RCA/Phono connectors on the rear panel, or via the optical TOSLINK connector (Port 1).

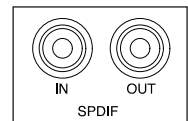

Loopback Input

Virtual Loopback inputs allow you to record any mix back into your DAW. This could be the audio output of another software application, or an entire monitor mix including analogue or digital inputs mixed with any playback signals that you wish to capture in your DAW.

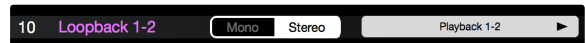

Loopback uses virtual inputs, which have no physical connectors on the hardware interface itself, but may be selected in the DAW as signal sources for recording in the same way as any other.

For RedNet Control information, see page 23.

Dante Connection

Two RJ45 connectors for the Dante network are located on the rear panel. Use standard Cat 5e or newer network cables to connect to the Dante audio network. Incorporated into each socket are LEDs which illuminate to indicate a valid network connection and network activity.

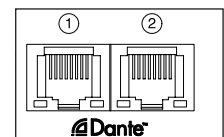

The ports can be configured as either:

- Switched Mode – a two-port switch, to allow the daisy-chaining of additional units, or
- Redundant Mode (default) – the primary and secondary paths of a redundant system, where two independent networks are available

The configuration of the ports is set from the Dante Controller application.

For more information on Dante networks, see Audinate's website: <http://www.audinate.com/>

Monitoring

Monitors

Monitor outputs, at line level, are provided via the 1/4" balanced jack outputs on the rear panel.

- The Output Encoder will adjust the monitor output level whenever the Monitor button is illuminated

Monitor Display

The monitor display shows the current volume level and whether either Dim or Mute is active. 'Dim' attenuates the signal by 18dB.

The L/R meter display shows a pre-fade level (the signal level present before the Output Encoder).

The display also shows the Global Host and Sync settings and their lock status flags (see 'Global Settings' on page 23).

Mute and Dim

Mute and Dim functions are individually enabled via the Monitor Setup menu. Additionally, the Output Encoder can be programmed to toggle either the Dim or Mute (default) function when clicked.

Menu activation:

- 1 Press-and-hold the **Monitor** button to enter the Setup menu
- 2 Rotate the Output Encoder to highlight either Dim or Mute
- 3 Click to select On or Off
- 4 To exit, press Monitor again (or select the 'Back' option)

Toggle Function programming:

- 1 Enter the Monitor Setup menu as above
- 2 Rotate to highlight the function to be programmed
- 3 Press-and-hold the Output Encoder until the confirmation message appears

The selected function will now toggle on/off each time the Output Encoder is clicked.

Headphones

Two independent stereo headphone outputs are available on the front panel.

- To adjust a headphone's volume level, or to activate Dim or Mute for that output, press one of the **Headphone Select** buttons

For Dim and Mute activation and programming, refer to the 'Mute and Dim' section above but substitute 'Monitor button' with the appropriate Headphone Select button.

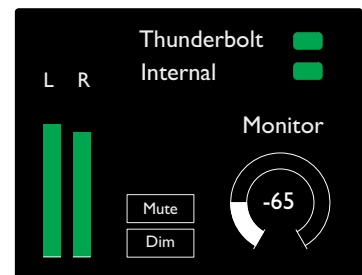

Monitor Display

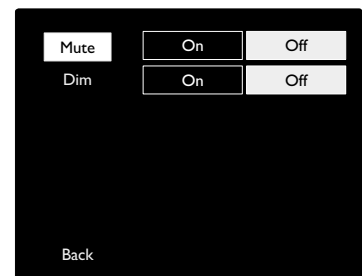

Monitor Setup Menu



Encoder Toggle Confirmation



Headphone Select Buttons

LCD Meter Displays

Red 4Pre, Red 8Pre and Red 8Line

The centre LCD screen displays eight level meters. These indicate the internal signal level after A-D conversion (or pre D-A conversion when monitoring outputs), with 0 dBFS being at full scale.

A red clip indicator is displayed on channels that reach clipping point.

The method of signal selection differs between each unit type:

Meter Source Selection – Red 4Pre and Red 8Pre

To select the source for the LCD display:

- 1 Press the **Meter** button on the front panel to access the Meter Source-List
- 2 Use the Output Encoder to scroll to the required input or output
- 3 Click the Output Encoder to make the selection
- 4 Press Monitor or one of the Headphone Select buttons to exit

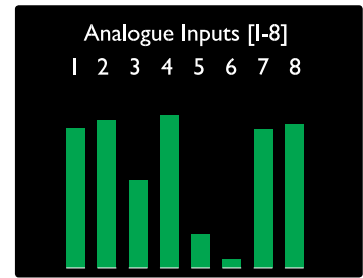

Red 4Pre / Red 8Pre

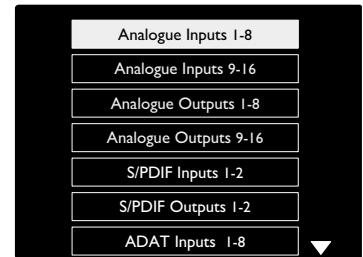

Meter Source List

Meter Source Selection – Red 8Line

Analogue inputs:

- Press **Analogue** to display analogue signals 1-8 on the centre screen
- Press Analogue again to toggle the display between inputs and outputs

Digital inputs:

- Press **Digital** to display digital signals on the centre screen; the meter source is selected using the Meter switch and the Output Encoder – see *Meter Source Selection - Red 4Pre and Red 8Pre, above*
- Press the Digital button again to toggle the display between inputs and outputs

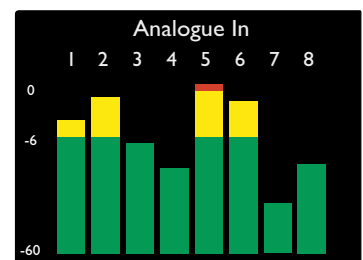

Red 8Line

Red 16Line

Level Meters 1–8 and 9–16

The left and centre LCD screens can both display level meters. These indicate the internal signal level of channels 1–16, after A-D conversion (or pre D-A conversion when monitoring outputs), with 0 dBFS being at full scale.

A red clip indicator is displayed on channels that reach clipping point.

Pressing the *METER* button toggles the displays between *preamp-info* and *meter-level* displays.

The meter source is selected as follows:

- Press the **Input** button to display input channels 1–8 and 9–16.
- Press the **Output** button to display output channels 1–8 and 9–16.
- Press both Input and Output buttons simultaneously to select the combined **I/O** view.

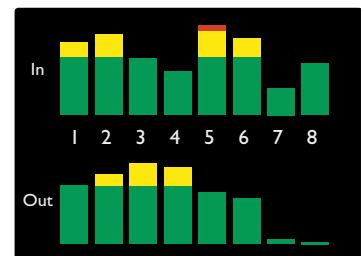
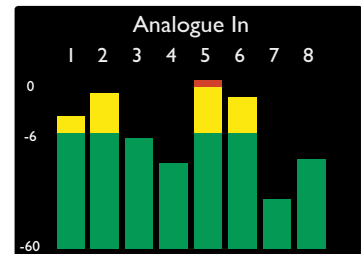

Combined I/O Display

Output Meter

The Output screen normally shows the Monitor or Headphone 1 or 2 level meters (as well as the interface status flags).

This screen is also used to select the meter source for displays 1 and 2.

Meter Source Selection

To select the signal source for the Left and Centre LCD displays:

- 1 Press the **Meter** button on the front panel twice to access the Meter Source-List
- 2 Use the Output Encoder to scroll to the required input
- 3 Click the Output Encoder to make the selection
- 4 Press Monitor or one of the Headphone buttons to exit

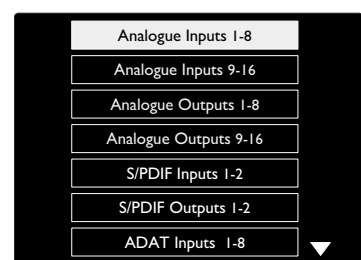
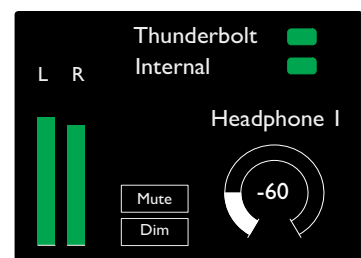

Meter Source List

Analogue Outputs

Analogue outputs are provided on DB25 female connector(s) on the rear panel.

The Line outputs for Red 4Pre and Red 8Pre are at fixed gain, where 0 dBFS corresponds to a signal level of +18 dBu.

Operating Level Selection

(Red 16Line only – also see: ‘Input/Output Line Level Setup’ on page 26.)

The operating level for each Line output can be switched between +18 dBu and +24 dBu to correctly match additional studio equipment.

- 1 Press and hold the **Output** button until the level selection menu appears on the Input Display
- 2 Scroll to the required channel number for individual selection or to **All** for global selection
- 3 Click the Input Encoder to toggle between +18 dBu and +24 dBu
- 4 Press the Output button again to exit

Input and output operating level selection can be linked or unlinked. Refer to: *Global Settings – I/O Level* on page 23 for additional information.

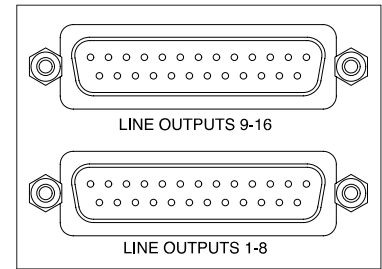

All	+18dBu	
Line 1	+24dBu	+18dBu
Line 2	+24dBu	+18dBu
Line 3	+24dBu	+18dBu
Line 4	+24dBu	+18dBu
Line 5	+24dBu	+18dBu
Line 6	+24dBu	+18dBu

Thunderbolt Connection

Confirm that your unit's Host setting is set to 'Thunderbolt', see *Global Host Settings* on page 23.

Two Thunderbolt 2 or Thunderbolt 3 connectors are located on the rear panel. Connect to the host, or into a chain, using standard Thunderbolt 2 or Thunderbolt 3 cables (one supplied).

See *appendix 3, pages 32–43* for the channel I/O allocation tables.

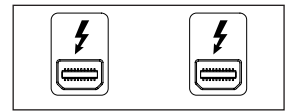

Thunderbolt 2

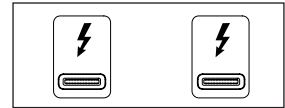

Thunderbolt 3

Logic Pro X Setup

- From the menu bar, go to: **Logic Pro X > Preferences > Audio...**
- Under the **Devices** tab, set: **Input Devices** and **Output Devices** to 'Focusrite Thunderbolt'



Pro Tools Connection

Confirm that your Red unit's Host setting is set to 'Pro Tools', see *Global Host Settings* on page 23.

Connect both rear panel PRIMARY ports to a Pro Tools | HDX card or HD Native system using Mini DigiLink cables.

Each Pro Tools | HDX PCIe card provides two Mini DigiLink ports (giving the card a capacity of 64 inputs and 64 outputs), thus one Red unit may be connected to each card.

A Red unit will appear as four devices in Pro Tools:

- A: 1-16 (Port 1)
- B: 1-16 (Port 1)
- C: 1-16 (Port 2)
- D: 1-16 (Port 2)

A maximum of three* Red range units can be connected, giving a total I/O capability of 174 inputs and 192 outputs.

**Or one if using an HD Native system.*

Note that both ports are Primary connectors; this means that an additional Pro Tools interface cannot be added in series – the ports do not operate in Expansion mode.

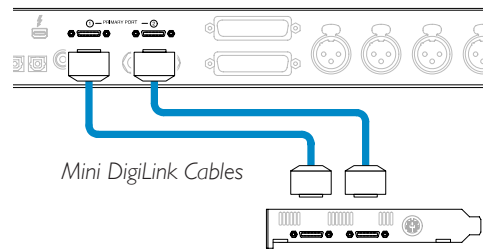

Using Red Range Units with other Pro Tools | HD interfaces

Pro Tools | HD I/O audio interfaces may be used on the same Pro Tools system as your Red unit. Pro Tools interface units can be added by using additional Pro Tools | HDX PCIe interface cards.

Connection to a Pro Tools | HD system would require the use of DigiLink-to-Mini DigiLink adapter cables.

Each unit will appear as four devices using HDX or HD Native, which is the maximum per card.

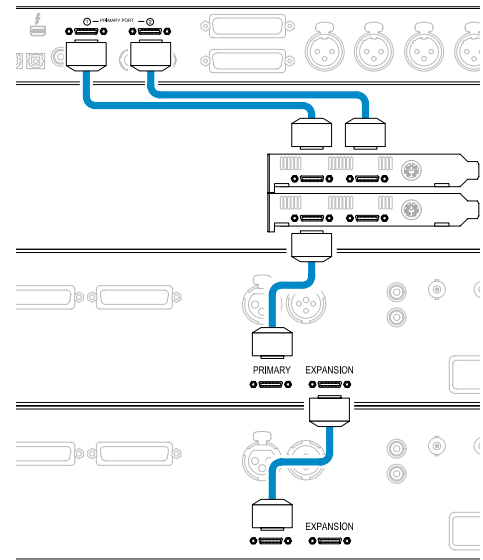

Loop Sync

It is important when using additional I/O devices that the Loop Sync connection is complete between all units:

- Using 75Ω BNC cables, connect each LOOP SYNC OUT connector to the LOOP SYNC IN connector on the next I/O unit
- Complete the chain by connecting LOOP SYNC OUT on the final I/O unit back to LOOP SYNC IN on the first unit

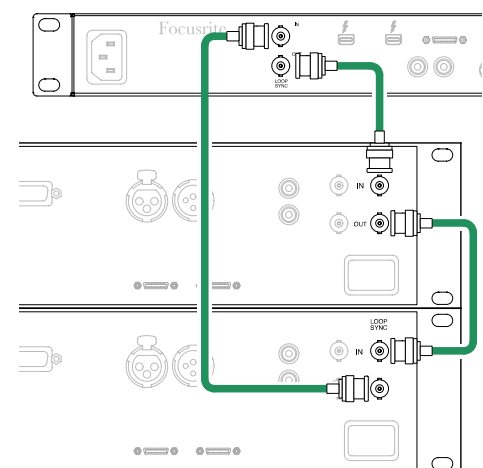

Pro Tools Setup

- From the Pro Tools menu bar, go to: **Setup > Playback Engine...**
- In the **Playback Engine** menu pop-up, select: 'HDX' or 'HD Native', as appropriate for your system

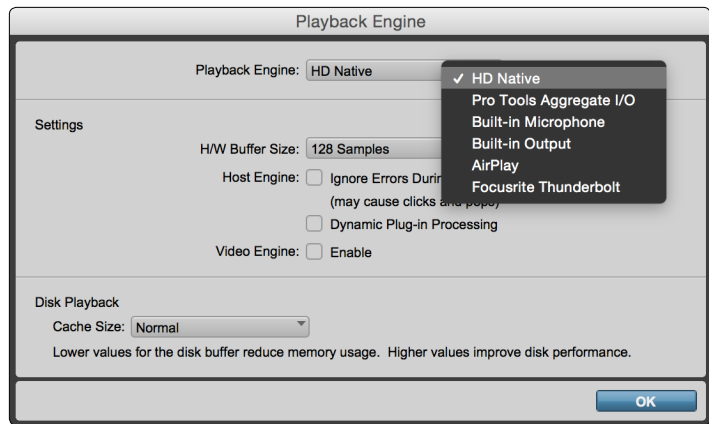

The following steps are optional but will simplify signal routing:

- From the menu bar, go to: **Setup > I/O Setup...**
- Ensure your input and output routing tables are routed as follows by selecting the **Default** tab at the bottom left of the page.

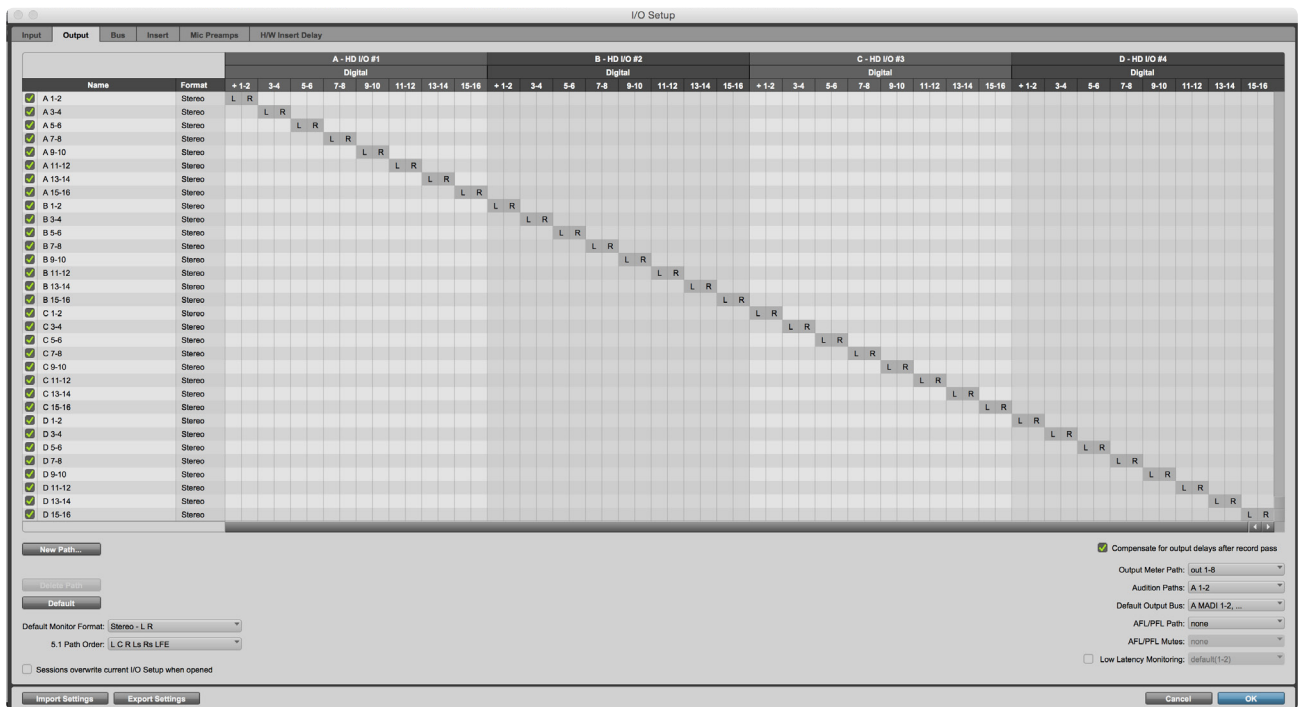

Notes

1. The number of input and output channels available is dependent on the sample frequency (see channel allocation tables in Appendix 3, pages 32–43)

GLOBAL SETTINGS

Press the **Meter** and **Monitor** buttons simultaneously to enter the **Global** settings menu.

- Rotate the Output Encoder to select a menu item
- Click the Output Encoder to step through the available options

To exit the Global settings screen press the Monitor button (or select the 'Back' option).



Host

Selects the connection used for the DAW host: Thunderbolt or Pro Tools. In Thunderbolt mode the Lock flag will show as locked whenever there is a connection to a Thunderbolt machine – whether or not a DAW is open; Pro Tools mode will require DAW connectivity to show lock.

Note: changing Host type will cause the device to perform a power reset.

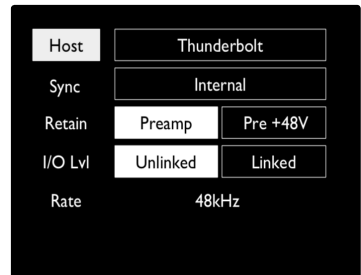

Global Settings Menu

Sync

Selects the unit's sync source:

- Internal – Internally generated. *This is the default selection*
- Word Clock – Received via the BNC Word Clock In connector
- ADAT 1 – Received via the rear Optical In 1-8 connector
- ADAT 2 – Received via the rear Optical In 9-16 connector
- S/PDIF – Received via either the rear RCA In connector, or Optical port 1 when set to 'Optical-S/PDIF'
- Dante – Provided by the Dante network connection
- Loop Sync – Only applicable when in 'Pro Tools Host' mode

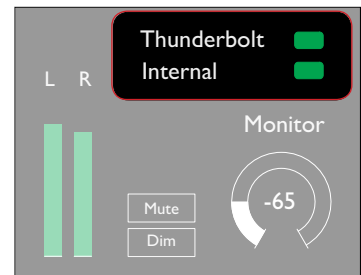

Host and Sync Settings and Lock Status

When sync is established, the Lock status will change to green. A red flag indicates no sync.

Retain

Choose whether the previous phantom power settings for Mic inputs are restored on power-up:

- Preamp – All previous settings are returned except the 48V settings, which will be set to Off. *This is the default selection*
- Preamp +48V – All previous settings are returned

I/O level *(Red 16Line only)*

- Linked (default) – Changes to a channel's I/O Reference level settings will be applied to the Input and Output values simultaneously
- Unlinked – Channel Input and Output Reference settings can be assigned independently

Selecting the "Linked" option when Input and Output levels are set to different values will not force a change in either value. The settings must be matched manually before subsequent changes will track.

OTHER RED SYSTEM COMPONENTS

RedNet Control 2

RedNet Control 2 is Focusrite’s customisable software application for controlling and configuring the Red and RedNet range of interfaces. Graphical representation for each device shows: controls, function settings, signal meters, signal routing and mixing.

Graphical control for the Red 4Pre, Red 8Pre and Red 16Line units is separated into five pages:

- I/O Control & Metering
- Monitor Control
- Input Routing
- Output Routing
- Custom Mixes



“I/O Control and Metering” Page

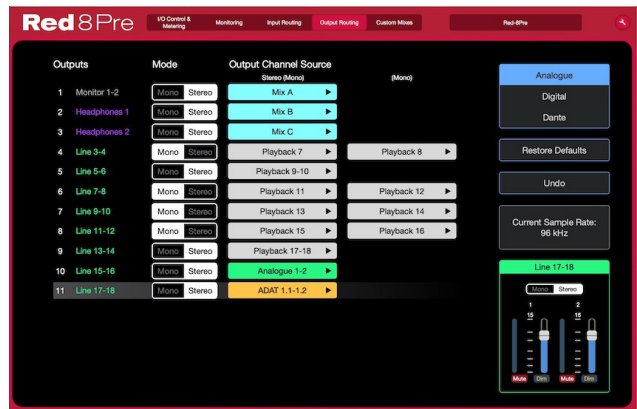

“Output Routing” Page

The images above indicate how access to all controls and settings is available using the application. Please refer to the section ‘Device Control’ in the RedNet Control Operator’s Manual for full details of operation and setup using the software.

Tools Menu

Clicking on the Tools icon  will bring up the System Settings window. The settings options are separated into three pages: Device, Setup and iOS.

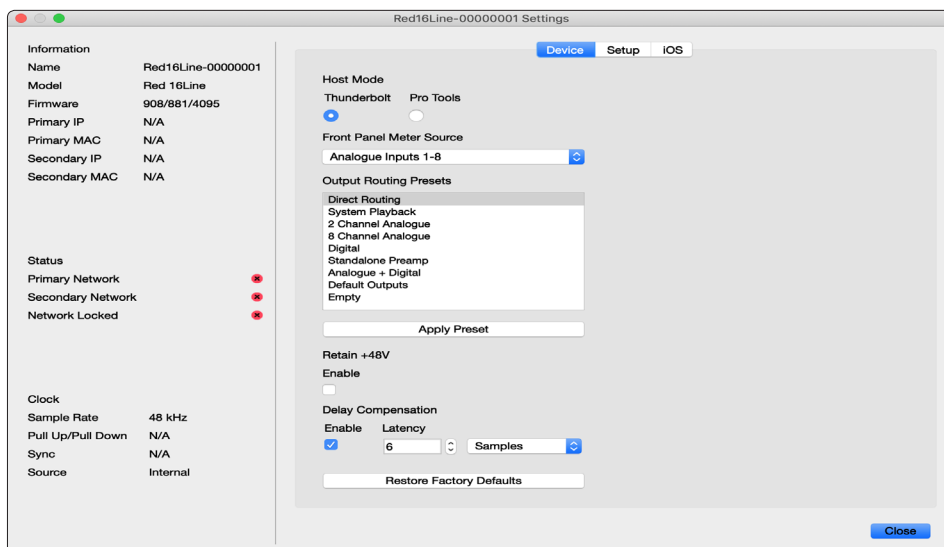

Tools Menu ...

Device Page:

Host Mode

- Thunderbolt
- Pro Tools

Front Panel Meter Source

- Analogue I/O
- S/PDIF I/O
- ADAT 1 I/O
- ADAT 2 I/O
- Dante 1-8 I/O
- Dante 9-16 I/O
- Dante 17-24 I/O
- Dante 25-32 I/O

Output Routing Presets – Select a saved preset from the list and click “Apply Preset” to activate.

Retain +48V – On/Off state. When enabled, power settings will be restored to their previous state on power-up.

Dante Delay Compensation (*Red 8Line and Red 16Line only*)

- Enable – On/Off state.
- Latency – Delays the Analogue Input and S/PDIF Input by 1 to 253 samples in order to align with the Dante Input. Can also be entered in milliseconds.

Restore Factory Defaults – Returns the unit to its factory settings.

Setup Page:

S/PDIF Source

- RCA
- Optical

When optical is selected, it will set optical input 1 and optical output 1 to the S/PDIF format

MIDI Channel – Set the MIDI channel (1 – 16) to which the unit will respond:

- Off
- MIDI Channel 1
- MIDI Channel 2
- ↓
- MIDI Channel 16

Notes:

- The default is “Off”
- 16 channels are available allowing a maximum of 16 independent Red unit control paths
- Two devices should not be set to the same MIDI channel
- MIDI channel selection is saved with the computer, not the device. Therefore, when controlling the same unit from a different computer the MIDI channel allocation may no longer be the same

For more information, please download the MIDI Control User Guide at: <http://www.focusrite.com/downloads>

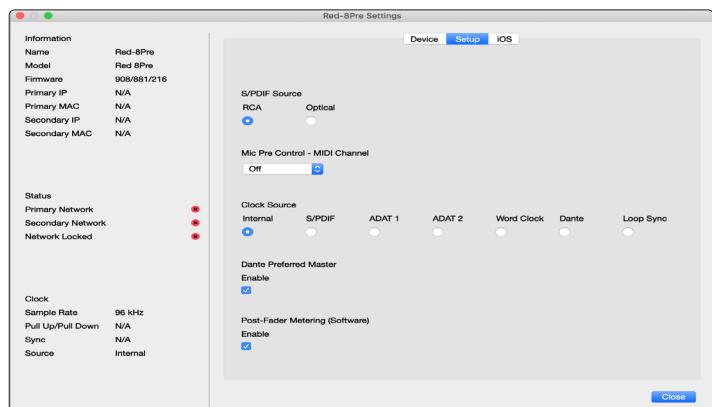

Clock Source

- Internal
- S/PDIF
- ADAT 1
- ADAT 2
- Word Clock
- Dante
- Loop Sync

Preferred Master – On/Off state.

Post-Fader Metering (Software)– On/Off state. When enabled, the Red device will change all of its metering from Pre-Fader Metering to Post-Fader Metering in the software only.

Metering Refresh Rate

- High
- Standard

Standard is recommended to lower CPU usage.

Input/Output Line Level Setup (Red 8Line and Red 16Line only)

- All: +18dBu / +24dBu
- Ch.1: +18dBu / +24dBu
- Ch.2: +18dBu / +24dBu
- Ch. 16: +18dBu / +24dBu

iOS Page:

Shows the list of iOS devices able to access the unit.

Each device can have its control access approved or be removed from the list.

The Red devices are controlled from the Focusrite Control iOS app.

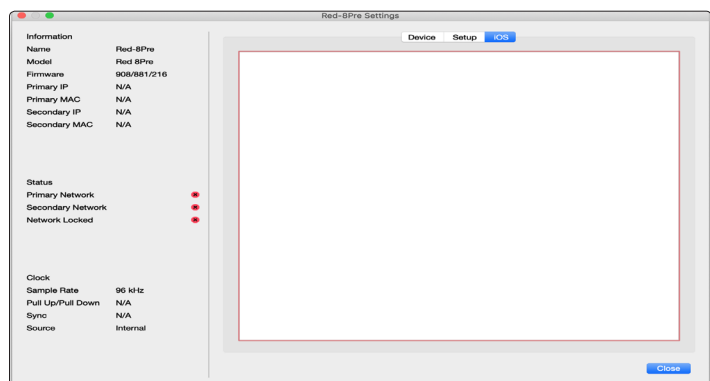

APPENDICES

Appendix 1 – Connector Pinouts

DB25 (AES59) Connector

Connectors are wired according to the AES59 Standard (also known as the TASCAM Analogue standard).

Connector type: DB25 female

Applies to: Analogue Line Input / Line Output
Mic Inputs (Red 8Pre only)

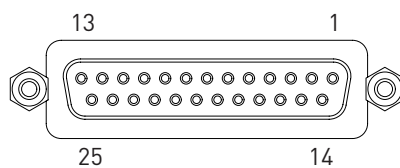

Pin	Signal
1	Channel 8 +
14	Channel 8 -
2	Ground
15	Channel 7 +
3	Channel 7 -
16	Ground
4	Channel 6 +
17	Channel 6 -
5	Ground
18	Channel 5 +
6	Channel 5 -
19	Ground
7	Channel 4 +
20	Channel 4 -
8	Ground
21	Channel 3 +
9	Channel 3 -
22	Ground
10	Channel 2 +
23	Channel 2 -
11	Ground
24	Channel 1 +
12	Channel 1 -
25	Ground
13	n/c

XLR Connectors

Connectors are wired according to the AES59 Standard (also known as the TASCAM Analogue standard).

Connector type: XLR-3 female

Applies to: Mic Inputs

Pin	Signal
1	Screen
2	Hot (+ve)
3	Cold (-ve)

1/4" Jack Connectors

Connector type: Balanced socket

Applies to: Monitor Outputs

Connector type: Unbalanced socket

Applies to: Instrument Inputs

Pin	Signal
Tip	Hot (+ve)
Ring	Cold (-ve)
Sleeve	Ground

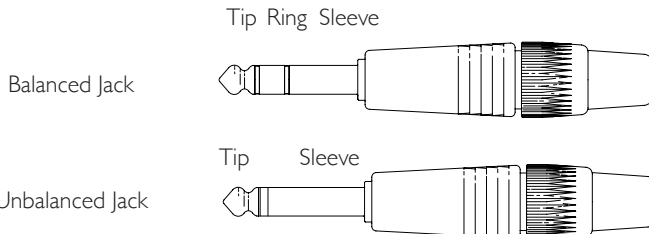

Pro Tools Interface

Connector type: Mini DigiLink receptacle

Applies to: PRIMARY 1 & 2

BNC Connectors

Connector type: 75Ω BNC socket

Applies to: WORD CLOCK IN/OUT
LOOP SYNC IN/OUT

Ethernet Connector

Connector type: RJ-45 receptacle

Applies to: Ethernet (Dante)

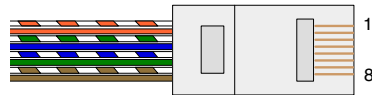

Pin	Cat 6 Core
1	White + Orange
2	Orange
3	White + Green
4	Blue
5	White + Blue
6	Green
7	White + Brown
8	Brown

Appendix 2 – System Diagrams

System Diagram: Red 4Pre

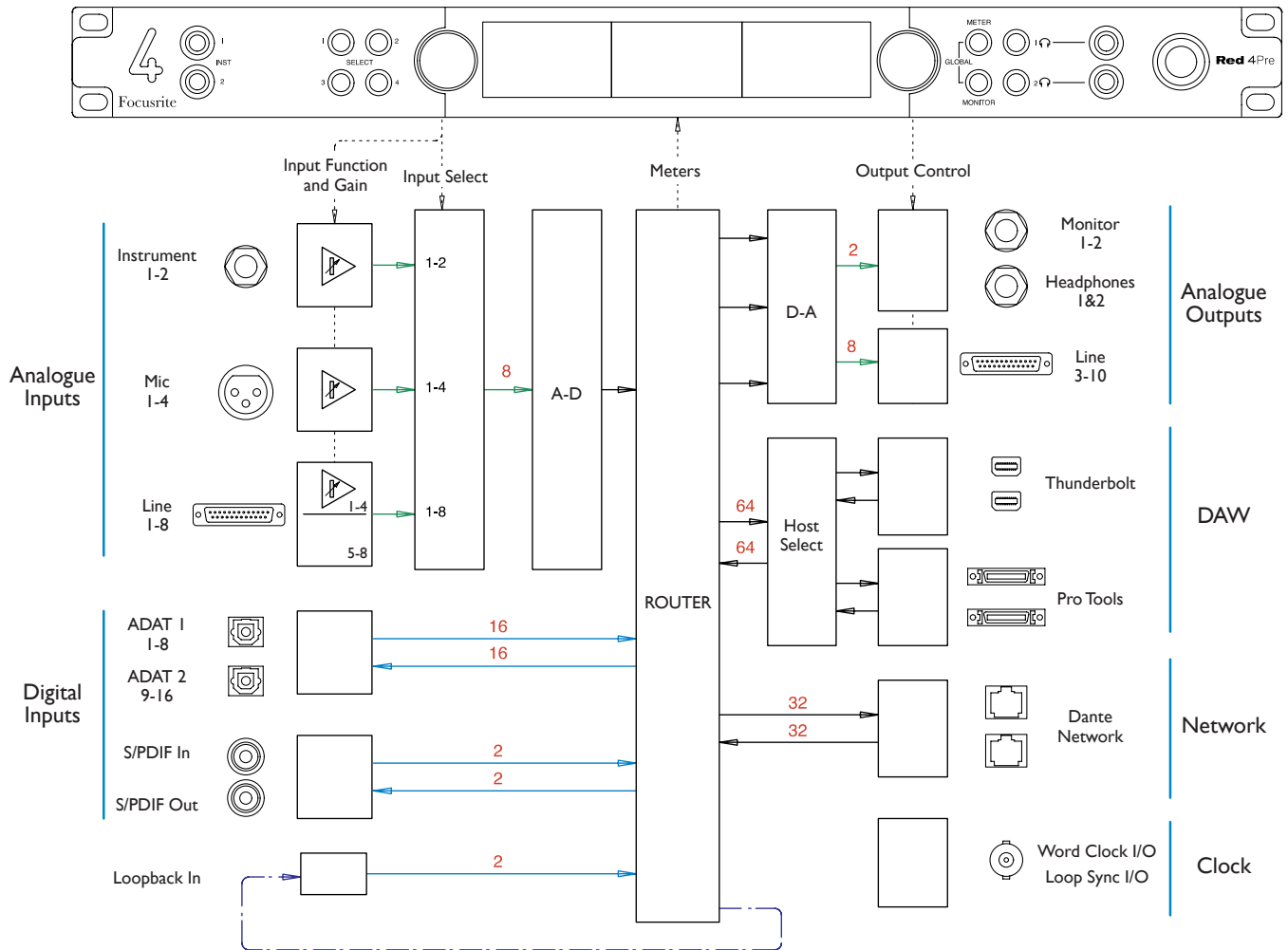

Numbers indicating channel capacities relate to a 44.1/48 kHz sample rate. Refer to the Channel I/O tables on pages 32–43 for the channel counts at higher sample rates.

System Diagram: Red 8Pre

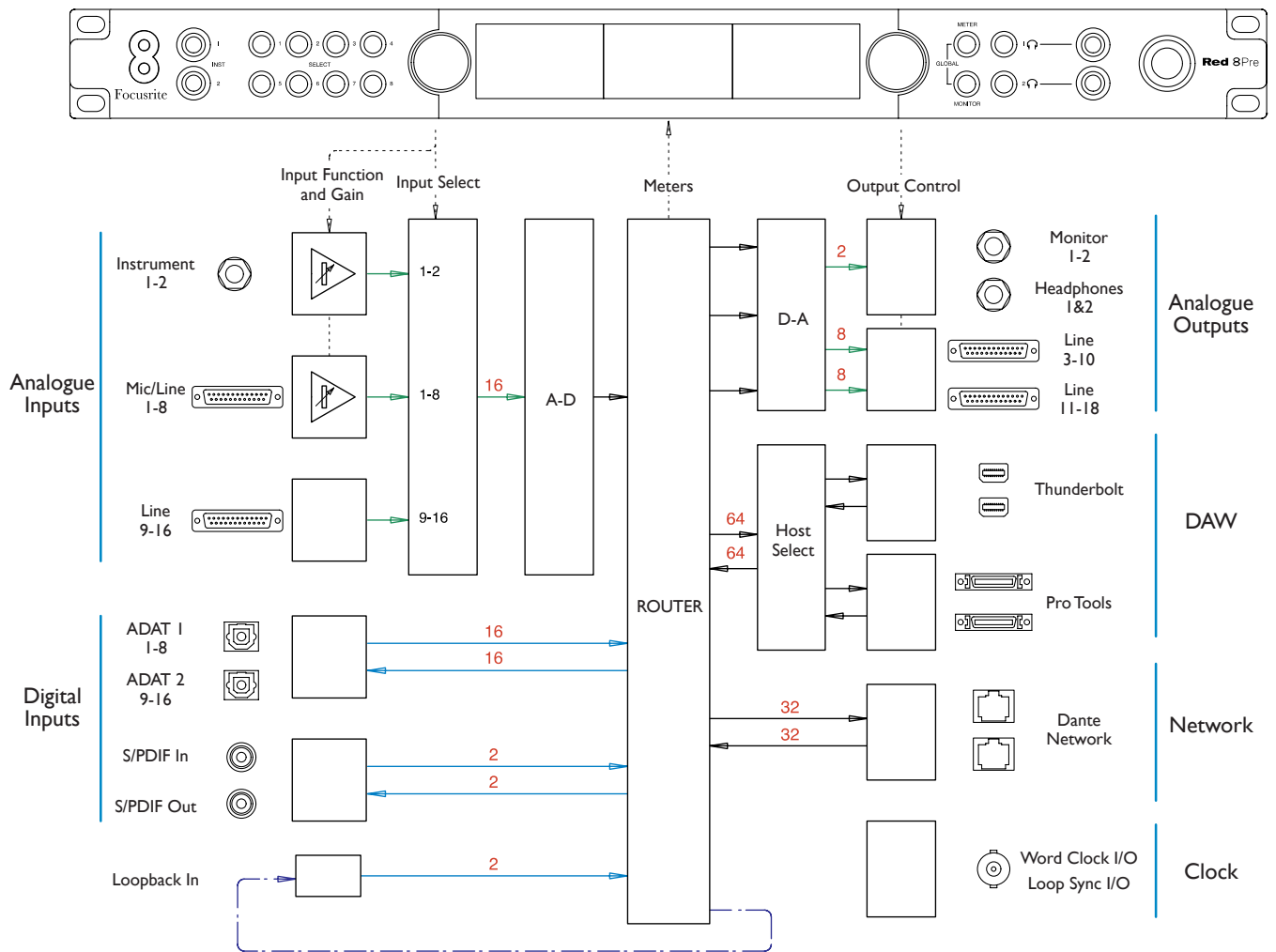

Numbers indicating channel capacities relate to a 44.1/48 kHz sample rate. Refer to the Channel I/O tables on pages 32–43 for the channel counts at higher sample rates.

System Diagram: Red 8Line and Red 16Line

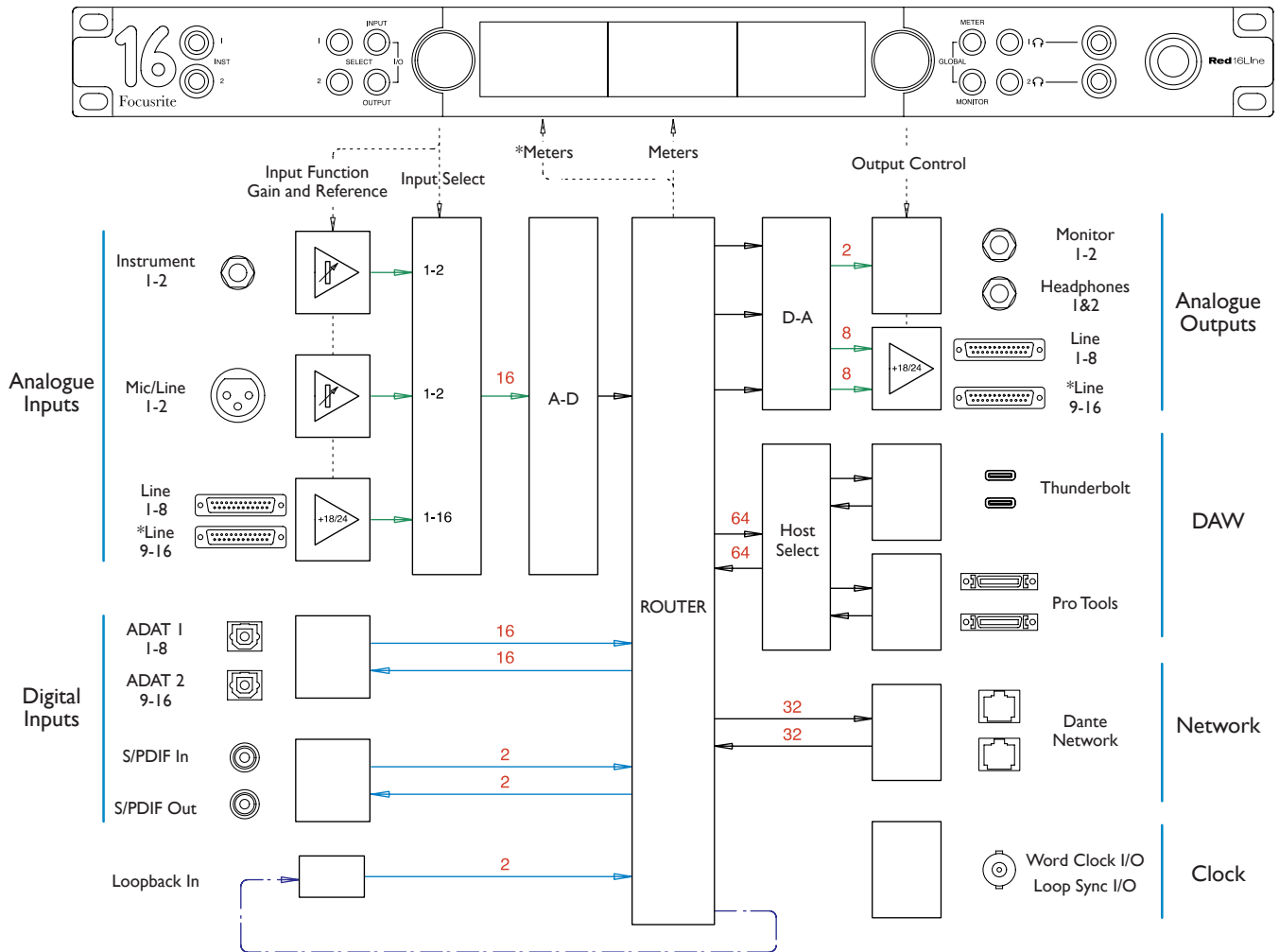

Numbers indicating channel capacities relate to a 44.1/48 kHz sample rate. Refer to the Channel I/O tables on pages 32–43 for the channel counts at higher sample rates.

*Red 16Line only

Appendix 3 – I/O Channel Allocation

Red 4Pre – 44.1 / 48 kHz

This is the input/output default routing allocation. The input and output ordering can be configured using RedNet Control when the unit is connected to a computer over Thunderbolt.

Note that the maximum physical I/O that can be connected is 58 in by 64 out.

Red 4Pre – Inputs		
1	Mic/Line/Inst	1
2		2
3	Mic/Line	3
4		4
5	Line In	5
6		6
7		7
8		8
9	S/PDIF	L
10		R
11	Loopback	L
12		R
13	ADAT 1	1
14		2
15		3
16		4
17		5
18		6
19		7
20		8
21	ADAT 2	9
22		10
23		11
24		12
25		13
26		14
27		15
28		16
29	Dante	1
30		2
31		3
32		4
33		5
34		6
35		7
36		8
37		9
38		10
39		11
40		12
41		13
42		14
43		15
44		16
45		17
46		18
47		19
48		20
49		21
50		22
51		23
52		24
53		25
54		26
55		27
56		28
57		29
58		30
59		31
60		32
	Not available	

Red 4Pre – Outputs		
1	Monitor	L
2		R
3	Headphone 1	L
4		R
5	Headphone 2	L
6		R
7	Line Out	3
8		4
9		5
10		6
11		7
12		8
13		9
14		10
15	S/PDIF	L
16		R
17	ADAT 1	1
18		2
19		3
20		4
21		5
22		6
23		7
24		8
25	ADAT 2	9
26		10
27		11
28		12
29		13
30		14
31		15
32		16
33	Dante	1
34		2
35		3
36		4
37		5
38		6
39		7
40		8
41		9
42		10
43		11
44		12
45		13
46		14
47		15
48		16
49		17
50		18
51		19
52		20
53		21
54		22
55		23
56		24
57		25
58		26
59		27
60		28
61		29
62		30
63		31
64		32

Red 4Pre – 88.2 / 96 kHz

This is the input/output default routing allocation. The input and output ordering can be configured using RedNet Control when the unit is connected to a computer over Thunderbolt.

Red 4Pre – Inputs		
1	Mic/Line/Inst	1
2		2
3	Mic/Line	3
4		4
5	Line In	5
6		6
7		7
8		8
9	S/PDIF	L
10		R
11	Loopback	L
12		R
13	ADAT 1	1
14		2
15		3
16		4
17	ADAT 2	9
18		10
19		11
20		12
21	Dante	1
22		2
23		3
24		4
25		5
26		6
27		7
28		8
29		9
30		10
31		11
32		12
33		13
34		14
35		15
36		16
37		17
38		18
39		19
40		20
41		21
42		22
43		23
44		24
45		25
46		26
47		27
48		28
49		29
50		30
51		31
52		32
	Not available	

Red 4Pre – Outputs			
1	Monitor	L	
2		R	
3	Headphone 1	L	
4		R	
5	Headphone 2	L	
6		R	
7	Line Out	3	
8		4	
9		5	
10		6	
11		7	
12		8	
13		9	
14		10	
15		S/PDIF	L
16			R
17	ADAT 1	1	
18		2	
19		3	
20		4	
21	ADAT 2	9	
22		10	
23		11	
24		12	
25	Dante	1	
26		2	
27		3	
28		4	
29		5	
30		6	
31		7	
32		8	
33		9	
34		10	
35		11	
36		12	
37		13	
38		14	
39		15	
40		16	
41		17	
42		18	
43		19	
44		20	
45		21	
46		22	
47		23	
48		24	
49		25	
50		26	
51		27	
52		28	
53		29	
54		30	
55		31	
56		32	
	Not available		

Red 4Pre – 176.4 / 192 kHz

This is the input/output default routing allocation. The input and output ordering can be configured using RedNet Control when the unit is connected to a computer over Thunderbolt.

Red 4Pre – Inputs		
1	Mic/Line/Inst	1
2		2
3	Mic/Line	3
4		4
5	Line In	5
6		6
7		7
8		8
9	S/PDIF	L
10		R
11	Loopback	L
12		R
13	ADAT 1	1
14		2
15	ADAT 2	9
16		10
17	Dante	1
18		2
19		3
20		4
21		5
22		6
23		7
24		8
25		9
26		10
27		11
28		12
29		13
30		14
31		15
32		16
	Not available	

Red 4Pre – Outputs			
1	Monitor	L	
2		R	
3	Headphone 1	L	
4		R	
5	Headphone 2	L	
6		R	
7	Line Out	3	
8		4	
9		5	
10		6	
11		7	
12		8	
13		9	
14		10	
15		S/PDIF	L
16			R
17	ADAT 1	1	
18		2	
19	ADAT 2	9	
20		10	
21	Dante	1	
22		2	
23		3	
24		4	
25		5	
26		6	
27		7	
28		8	
29		9	
30		10	
31		11	
32		12	
33		13	
34		14	
35		15	
36		16	
	Not available		

Red 8Pre – 44.1 / 48 kHz

This is the input/output default routing allocation. The input and output ordering can be configured using RedNet Control when the unit is connected to a computer over Thunderbolt.

Red 8Pre – Inputs		
1	Mic/Line/Inst	1
2		2
3	Mic/Line	3
4		4
5		5
6		6
7		7
8		8
9	Line In	9
10		10
11		11
12		12
13		13
14		14
15		15
16		16
17	S/PDIF	L
18		R
19	Loopback	L
20		R
21	ADAT 1	1
22		2
23		3
24		4
25		5
26		6
27		7
28		8
29	ADAT 2	9
30		10
31		11
32		12
33		13
34		14
35		15
36		16
37	Dante	1
38		2
39		3
40		4
41		5
42		6
43		7
44		8
45		9
46		10
47		11
48		12
49		13
50		14
51		15
52		16
53	17	
54	18	
55	19	
56	20	
57	21	
58	22	
59	23	
60	24	
61	25	
62	26	
63	27	
64	28	
65	29	
66	30	
67	31	
68	32	
69	Not available	
70		
71		
72		

Red 8Pre – Outputs		
1	Monitor	L
2		R
3	Headphone 1	L
4		R
5	Headphone 2	L
6		R
7	Line Out	3
8		4
9		5
10		6
11		7
12		8
13		9
14		10
15		11
16		12
17	13	
18	14	
19	15	
20	16	
21	17	
22	18	
23	S/PDIF	L
24		R
25	ADAT 1	1
26		2
27		3
28		4
29		5
30		6
31		7
32		8
33	ADAT 2	9
34		10
35		11
36		12
37		13
38		14
39		15
40		16
41	Dante	1
42		2
43		3
44		4
45		5
46		6
47		7
48		8
49		9
50		10
51		11
52		12
53		13
54		14
55		15
56		16
57	17	
58	18	
59	19	
60	20	
61	21	
62	22	
63	23	
64	24	
65	25	
66	26	
67	27	
68	28	
69	29	
70	30	
71	31	
72	32	

Red 8Pre – 88.2 / 96 kHz

This is the input/output default routing allocation. The input and output ordering can be configured using RedNet Control when the unit is connected to a computer over Thunderbolt.

Red 8Pre – Inputs		
1	Mic/Line/Inst	1
2		2
3	Mic/Line	3
4		4
5		5
6		6
7		7
8		8
9	Line In	9
10		10
11		11
12		12
13		13
14		14
15		15
16		16
17	S/PDIF	L
18		R
19	Loopback	L
20		R
21	ADAT 1	1
22		2
23		3
24		4
25	ADAT 2	9
26		10
27		11
28		12
29	Dante	1
30		2
31		3
32		4
33		5
34		6
35		7
36		8
37		9
38		10
39		11
40		12
41	13	
42	14	
43	15	
44	16	
45	17	
46	18	
47	19	
48	20	
49	21	
50	22	
51	23	
52	24	
53	25	
54	26	
55	27	
56	28	
57	29	
58	30	
59	31	
60	32	
	Not available	

Red 8Pre – Outputs			
1	Monitor	L	
2		R	
3	Headphone 1	L	
4		R	
5	Headphone 2	L	
6		R	
7	Line Out	3	
8		4	
9		5	
10		6	
11		7	
12		8	
13		9	
14		10	
15		S/PDIF	11
16			12
17	13		
18	14		
19	15		
20	16		
21	17		
22	18		
23	S/PDIF	L	
24		R	
25	ADAT 1	1	
26		2	
27		3	
28		4	
29	ADAT 2	9	
30		10	
31		11	
32		12	
33	Dante	1	
34		2	
35		3	
36		4	
37		5	
38		6	
39		7	
40		8	
41		9	
42		10	
43		11	
44		12	
45	13		
46	14		
47	15		
48	16		
49	17		
50	18		
51	19		
52	20		
53	21		
54	22		
55	23		
56	24		
57	25		
58	26		
59	27		
60	28		
61	29		
62	30		
63	31		
64	32		

Red 8Pre – 176.4 / 192 kHz

This is the input/output default routing allocation. The input and output ordering can be configured using RedNet Control when the unit is connected to a computer over Thunderbolt.

Red 8Pre – Inputs		
1	Mic/Line/Inst	1
2		2
3	Mic/Line	3
4		4
5		5
6		6
7		7
8		8
9	Line In	9
10		10
11		11
12		12
13		13
14		14
15		15
16		16
17	S/PDIF	L
18		R
19	Loopback	L
20		R
21	ADAT 1	1
22		2
23	ADAT 2	9
24		10
25	Dante	1
26		2
27		3
28		4
29		5
30		6
31		7
32		8
33	9	
34	10	
35	11	
36	12	
37	13	
38	14	
39	15	
40	16	
	Not available	

Red 8Pre – Outputs		
1	Monitor	L
2		R
3	Headphone 1	L
4		R
5	Headphone 2	L
6		R
7	Line Out	3
8		4
9		5
10		6
11		7
12		8
13		9
14		10
15		11
16		12
17	13	
18	14	
19	15	
20	16	
21	17	
22	18	
23	S/PDIF	L
24		R
25	ADAT 1	1
26		2
27	ADAT 2	9
28		10
29	Dante	1
30		2
31		3
32		4
33		5
34		6
35		7
36		8
37	9	
38	10	
39	11	
40	12	
41	13	
42	14	
43	15	
44	16	
	Not available	

Red 8Line – 44.1 / 48 kHz

This is the input/output default routing allocation. The input and output ordering can be configured using RedNet Control when the unit is connected to a computer over Thunderbolt.

Note that the maximum physical I/O that can be connected is 58 in by 64 out.

Red 8Line – Inputs		
1	Mic/Line/Inst	1
2		2
3	Line	3
4		4
5		5
6		6
7		7
8		8
9	Loopback	L
10		R
11	S/PDIF	L
12		R
13	ADAT 1	1
14		2
15		3
16		4
17		5
18		6
19		7
20		8
21	ADAT 2	9
22		10
23		11
24		12
25		13
26		14
27		15
28		16
29	Dante	1
30		2
31		3
32		4
33		5
34		6
35		7
36		8
37		9
38		10
39		11
40		12
41		13
42		14
43		15
44		16
45	17	
46	18	
47	19	
48	20	
49	21	
50	22	
51	23	
52	24	
53	25	
54	26	
55	27	
56	28	
57	29	
58	30	
59	31	
60	32	
61	Not available	
62		
63		
64		
65		
66		
67		
68		

Red 8Line – Outputs		
1	Line (Monitor/HP1)	1 (L)
2		2 (R)
3	Line	3
4		4
5		5
6		6
7		7
8		8
9	Headphone 2	L
10		R
11	S/PDIF	L
12		R
13	ADAT 1	1
14		2
15		3
16		4
17		5
18		6
19		7
20		8
21	ADAT 2	9
22		10
23		11
24		12
25		13
26		14
27		15
28		16
29	Dante	1
30		2
31		3
32		4
33		5
34		6
35		7
36		8
37		9
38		10
39		11
40		12
41		13
42		14
43		15
44		16
45	17	
46	18	
47	19	
48	20	
49	21	
50	22	
51	23	
52	24	
53	25	
54	26	
55	27	
56	28	
57	29	
58	30	
59	31	
60	32	
61	Not available	
62		
63		
64		
65		
66		
67		
68		

Red 8Line – 88.2 / 96 kHz

This is the input/output default routing allocation. The input and output ordering can be configured using RedNet Control when the unit is connected to a computer over Thunderbolt.

Red 8Line – Inputs		
1	Mic/Line/Inst	1
2		2
3	Line	3
4		4
5		5
6		6
7		7
8		8
9	Loopback	L
10		R
11	S/PDIF	L
12		R
13	ADAT 1	1
14		2
15		3
16		4
17	ADAT 2	9
18		10
19		11
20		12
21		Dante
22	2	
23	3	
24	4	
25	5	
26	6	
27	7	
28	8	
29	9	
30	10	
31	11	
32	12	
33	13	
34	14	
35	15	
36	16	
37	17	
38	18	
39	19	
40	20	
41	21	
42	22	
43	23	
44	24	
45	25	
46	26	
47	27	
48	28	
49	29	
50	30	
51	31	
52	32	
	Not available	

Red 8Line – Outputs		
1	Line (Monitor/HP1)	1 (L)
2		2 (R)
3	Line	3
4		4
5		5
6		6
7		7
8		8
9	Headphone 2	L
10		R
11	S/PDIF	L
12		R
13	ADAT 1	1
14		2
15		3
16		4
17	ADAT 2	9
18		10
19		11
20		12
21		Dante
22	2	
23	3	
24	4	
25	5	
26	6	
27	7	
28	8	
29	9	
30	10	
31	11	
32	12	
33	13	
34	14	
35	15	
36	16	
37	17	
38	18	
39	19	
40	20	
41	21	
42	22	
43	23	
44	24	
45	25	
46	26	
47	27	
48	28	
49	29	
50	30	
51	31	
52	32	
	Not available	

Red 8Line – 176.4 / 192 kHz

This is the input/output default routing allocation. The input and output ordering can be configured using RedNet Control when the unit is connected to a computer over Thunderbolt.

Red 8Line – Inputs		
1	Mic/Line/Inst	1
2		2
3	Line	3
4		4
5		5
6		6
7		7
8		8
9	Loopback	L
10		R
11	S/PDIF	L
12		R
13	ADAT 1	1
14		2
15	ADAT 2	9
16		10
17	Dante	1
18		2
19		3
20		4
21		5
22		6
23		7
24		8
25		9
26		10
27		11
28		12
29		13
30		14
31		15
32		16
	Not available	

Red 8Line – Outputs		
1	Line (Monitor/HP1)	1 (L)
2		2 (R)
3	Line	3
4		4
5		5
6		6
7		7
8		8
9	Headphone 2	L
10		R
11	S/PDIF	L
12		R
13	ADAT 1	1
14		2
15	ADAT 2	9
16		10
17	Dante	1
18		2
19		3
20		4
21		5
22		6
23		7
24		8
25		9
26		10
27		11
28		12
29		13
30		14
31		15
32		16
	Not available	

Red 16Line – 44.1 / 48 kHz

This is the input/output default routing allocation. The input and output ordering can be configured using RedNet Control when the unit is connected to a computer over Thunderbolt.

Red 16Line – Inputs		
1	Mic/Line/Inst	1
2		2
3	Line	3
4		4
5		5
6		6
7		7
8		8
9		9
10		10
11		11
12		12
13		13
14		14
15		15
16		16
17	Loopback	L
18		R
19	S/PDIF	L
20		R
21	ADAT 1	1
22		2
23		3
24		4
25		5
26		6
27		7
28		8
29	ADAT 2	9
30		10
31		11
32		12
33		13
34		14
35		15
36		16
37	Dante	1
38		2
39		3
40		4
41		5
42		6
43		7
44		8
45		9
46		10
47		11
48		12
49		13
50		14
51		15
52		16
53	17	
54	18	
55	19	
56	20	
57	21	
58	22	
59	23	
60	24	
61	25	
62	26	
63	27	
64	28	
65	29	
66	30	
67	31	
68	32	

Red 16Line – Outputs		
1	Line (Monitor/HP1)	1 (L)
2		2 (R)
3	Line	3
4		4
5		5
6		6
7		7
8		8
9		9
10		10
11		11
12		12
13		13
14		14
15		15
16		16
17	Headphone 2	L
18		R
19	S/PDIF	L
20		R
21	ADAT 1	1
22		2
23		3
24		4
25		5
26		6
27		7
28		8
29	ADAT 2	9
30		10
31		11
32		12
33		13
34		14
35		15
36		16
37	Dante	1
38		2
39		3
40		4
41		5
42		6
43		7
44		8
45		9
46		10
47		11
48		12
49		13
50		14
51		15
52		16
53	17	
54	18	
55	19	
56	20	
57	21	
58	22	
59	23	
60	24	
61	25	
62	26	
63	27	
64	28	
65	29	
66	30	
67	31	
68	32	

Red 16Line – 88.2 / 96 kHz

This is the input/output default routing allocation. The input and output ordering can be configured using RedNet Control when the unit is connected to a computer over Thunderbolt.

Red 16Line – Inputs		
1	Mic/Line/Inst	1
2		2
3	Line	3
4		4
5		5
6		6
7		7
8		8
9		9
10		10
11		11
12		12
13		13
14		14
15		15
16		16
17	Loopback	L
18		R
19	S/PDIF	L
20		R
21	ADAT 1	1
22		2
23		3
24		4
25	ADAT 2	9
26		10
27		11
28		12
29	Dante	1
30		2
31		3
32		4
33		5
34		6
35		7
36		8
37		9
38		10
39		11
40		12
41		13
42		14
43		15
44		16
45	17	
46	18	
47	19	
48	20	
49	21	
50	22	
51	23	
52	24	
53	25	
54	26	
55	27	
56	28	
57	29	
58	30	
59	31	
60	32	
	Not available	

Red 16Line – Outputs		
1	Line (Monitor/HP1)	1 (L)
2		2 (R)
3	Line	3
4		4
5		5
6		6
7		7
8		8
9		9
10		10
11		11
12		12
13		13
14		14
15		15
16		16
17	Headphone 2	L
18		R
19	S/PDIF	L
20		R
21	ADAT 1	1
22		2
23		3
24		4
25	ADAT 2	9
26		10
27		11
28		12
29	Dante	1
30		2
31		3
32		4
33		5
34		6
35		7
36		8
37		9
38		10
39		11
40		12
41		13
42		14
43		15
44		16
45	17	
46	18	
47	19	
48	20	
49	21	
50	22	
51	23	
52	24	
53	25	
54	26	
55	27	
56	28	
57	29	
58	30	
59	31	
60	32	
	Not available	

Red 16Line – 176.4 / 192 kHz

This is the input/output default routing allocation. The input and output ordering can be configured using RedNet Control when the unit is connected to a computer over Thunderbolt.

Red 16Line – Inputs		
1	Mic/Line/Inst	1
2		2
3	Line	3
4		4
5		5
6		6
7		7
8		8
9		9
10		10
11		11
12		12
13		13
14		14
15		15
16		16
17	Loopback	L
18		R
19	S/PDIF	L
20		R
21	ADAT 1	1
22		2
23	ADAT 2	9
24		10
25	Dante	1
26		2
27		3
28		4
29		5
30		6
31		7
32		8
33		9
34		10
35		11
36		12
37		13
38		14
39		15
40		16
	Not available	

Red 16Line – Outputs		
1	Line (Monitor/HP1)	1 (L)
2		2 (R)
3	Line	3
4		4
5		5
6		6
7		7
8		8
9		9
10		10
11		11
12		12
13		13
14		14
15		15
16		16
17	Headphone 2	L
18		R
19	S/PDIF	L
20		R
21	ADAT 1	1
22		2
23	ADAT 2	9
24		10
25	Dante	1
26		2
27		3
28		4
29		5
30		6
31		7
32		8
33		9
34		10
35		11
36		12
37		13
38		14
39		15
40		16
	Not available	

Appendix 4 – Air Information

Air is the name we give to the sonic signature of the classic transformer ISA Preamp. Our customers first coined this name as a simple description of the effect the ISA preamp added to their sound recordings. The three most significant attributes of the transformer design that create the “Air” effect are:

- Microphone interaction, created by the unique input impedance of the transformer coupling with the microphone output impedance.
- Clarity, created by the low distortion and high linearity of the transformer and preamp design.
- Frequency response tilt created by the transformer resonance resulting in an emphasis in the higher frequency content of the sound.

Engaging the Air switches the impedance of the preamp, and enables the “transformer resonance effect”, giving your microphone recordings the air and clarity of an ISA transformer-based mic pre recording.

PERFORMANCE AND SPECIFICATIONS

Microphone Inputs	
Gain Range	0-8 to 63 dB in 1dB steps
Maximum Input Level	+19 dBu
Input Impedance	6.2 k Ω , electronically balanced Air Mode: 2.2 k Ω
Dynamic Range	119 dB 'A'-Weighted (typical), minimum gain
Frequency Response	20 Hz – 35 kHz \pm 0.2dB Air Mode: 2dB boost at 10 kHz and -2 dB at 20 kHz (ref. 1 kHz)
THD + N	0.0009% @ -1 dBFS
HPF	-3 dB @ 80 Hz, 12 dB/octave
EIN	-131 dBu 'A'-Weighted (typical)

Line Inputs	
Maximum Input Level	+27 dBu \pm 0.5, minimum gain (<i>Red 4Pre and Red 8Pre</i>) +18 or +24 dBu 0 dBFS switchable per channel (<i>Red 16Line</i>)
Dynamic Range	119 dB 'A'-Weighted
Frequency Response	20 Hz – 35 kHz \pm 0.2 dB Air Mode: 2dB boost at 10 kHz and -2 dB at 20 kHz (ref. 1 kHz)
THD + N	0.0009% (<i>Channels with variable gain</i>) 0.0006% (<i>Channels with fixed gain</i>)
HPF	-3 dB @ 80 Hz, 12 dB/octave
CMRR	-77 dB 50/60 Hz

Instrument Inputs	
Gain Range	0-8 to 63 dB in 1dB steps
Maximum Input Level	+15 dBu
Input Impedance	2.3 M Ω
Dynamic Range	117 dB 'A'-Weighted
Frequency Response	20 Hz – 35 kHz \pm 0.2 dB Air Mode: 2dB boost at 10 kHz and -2 dB at 20 kHz (ref. 1 kHz)
THD + N	0.0009% @ -1 dBFS
HPF	-3 dB @ 80 Hz, 12 dB/octave

Line Outputs	
Maximum Output Level	+18 dBu 0 dBFS (<i>Red 4Pre and Red 8Pre</i>) +18 or +24 dBu 0 dBFS switchable per channel (<i>Red 16Line</i>)
Dynamic Range	121 dB 'A'-Weighted
Frequency Response	20 Hz – 35 kHz \pm 0.3 dB
THD + N	0.0006%

Monitor Outputs	
Maximum Output Level	+18 dBu 0 dBFS
Dynamic Range	120 dB 'A'-Weighted
Frequency Response	20 Hz – 35 kHz ±0.2 dB
THD + N	0.012%

Headphone Outputs	
Maximum Output Level	+16 dBu
Dynamic Range	114 dB 'A'-Weighted
Frequency Response	20 Hz – 20 kHz ±0.2 dB
THD + N	0.018%
Output Impedance	10 Ω
Headphone Impedance	32 – 600 Ω

Digital Performance	
Supported Sample Rates	44.1 kHz, 48 kHz, 88.2 kHz, 96 kHz, 176.4 kHz, 192 kHz 24 bit
Clock Sources	Internal, ADAT, S/PDIF, Word Clock, Loop Sync or from Dante Network Master

Connectivity	
Front Panel	
Instrument Input	2 x 1/4" TS stereo Jack
Headphone Output	2 x 1/4" TRS stereo Jack
Rear Panel	
Thunderbolt	2 x Thunderbolt 2 or 3 connections
Pro Tools HD	2 x Mini DigiLink
Dante	2 x Ethernet standard RJ45 (Cat 5e and above)
Mic Input	[4/2] x XLR-3F (Red 4Pre & Red 16Line) 1 x DB25-F (Red 8Pre)
Line Input	2 x DB25-F
Line Output	2 x DB25-F
ADAT	2 x TOSLINK input, 2 x TOSLINK output
S/PDIF	RCA Phono (TOSLINK up to 96 kHz) input, RCA Phono (TOSLINK up to 96 kHz) output
Monitor Output	2 x 1/4" TRS stereo Jack
Loop Sync	BNC 75Ω input, BNC 75Ω output,
Word Clock	BNC 75Ω input, BNC 75Ω output,
PSU	IEC

Dimensions	
Height	44 mm / 1.73" [1RU]
Width	483 mm / 19"
Depth	340 mm / 13.4"

Weight	
Weight	[4.59 / 5.14 / 4.84 / 5.04] kg [10.12 / 11.33 / 16.67 / 11.11] lbs

Power	
PSU	Internal, 100-240 V, 50/60 Hz, consumption [35 / 65 / 120 / 120] W

Focusrite Pro Warranty and Service

All Focusrite products are built to the highest standards and should provide reliable performance for many years, subject to reasonable care, use, transportation and storage.

Very many of the products returned under warranty are found not to exhibit any fault at all. To avoid unnecessary inconvenience to you in terms of returning the product please contact Focusrite support.

In the event of a Manufacturing Defect becoming evident in a product within 24 months from the date of the original purchase Focusrite will ensure that the product is repaired or replaced free of charge.

A Manufacturing Defect is defined as a defect in the performance of the product as described and published by Focusrite. A Manufacturing Defect does not include damage caused by post-purchase transportation, storage or careless handling, nor damage caused by misuse.

Whilst this warranty is provided by Focusrite the warranty obligations are fulfilled by the distributor responsible for the country in which you purchased the product.

In the event that you need to contact the distributor regarding a warranty issue, or an out-of-warranty chargeable repair, please visit: www.focusrite.com/distributors

The distributor will then advise you of the appropriate procedure for resolving the warranty issue. In every case it will be necessary to provide a copy of the original invoice or store receipt to the distributor. In the event that you are unable to provide proof of purchase directly then you should contact the reseller from whom you purchased the product and attempt to obtain proof of purchase from them.

Please do note that if you purchase a Focusrite product outside your country of residence or business you will not be entitled to ask your local Focusrite distributor to honour this limited warranty, although you may request an out-of-warranty chargeable repair.

This limited warranty is offered solely to products purchased from an Authorised Focusrite Reseller (defined as a reseller which has purchased the product directly from Focusrite Audio Engineering Limited in the UK, or one of its Authorised Distributors outside the UK). This Warranty is in addition to your statutory rights in the country of purchase.

Registering Your Product

Please register your product at: www.focusrite.com/register

Customer Support and Unit Servicing

You can contact our Customer Support team:

Email: focusriteprosupport@focusrite.com

Phone (UK): +44 (0)1494 836 384

Phone (USA): +1 (310) 450 8494

Troubleshooting

If you are experiencing problems with your Red range unit, we recommend that in the first instance, you visit our Support Answerbase at: <https://pro.focusrite.com/technical-support>